

NORWOLF[®]



TOOL WORKS



MISSING LINK[™]

The gearless offset torque multiplier for all industries.

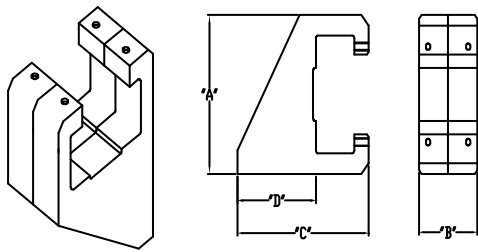

OPTIONAL REACTION ARM

MODEL	"A"	"B"	"C"	"D"
TC-050	3.75"	1.62"	4.50"	2.68"
TC-075-4-1	4.75"	2.38"	5.25"	2.87"
TC-075-6-1	5.00"	2.62"	6.25"	3.87"

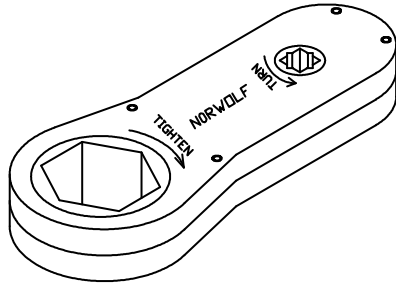

MISSING LINK™

TC SERIES™

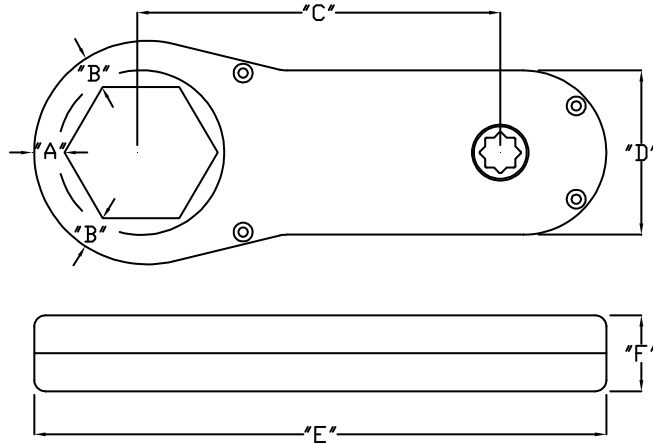

IMPERIAL

MISSING LINK 1/2" DRIVE, 4:1 RATIO

MAXIMUM TORQUE: 250 FT. LBS. INPUT / 1000 FT. LBS. OUTPUT

PART NO.	HEX	"A"	"B"	"C"	"D"	"E"	"F"
TC-050-4-1-087-S	7/8"	.600"	.662"	5.96"	2.75"	8.77"	1.25"
TC-050-4-1-106-S	1-1/16"	.437"	.500"	5.96"	2.75"	8.77"	1.25"
TC-050-4-1-125-S	1-1/4"	.437"	.500"	5.96"	2.75"	8.88"	1.25"
TC-050-4-1-143-S	1-7/16"	.437"	.500"	5.96"	2.75"	8.99"	1.25"
TC-050-4-1-162-S	1-5/8"	.437"	.500"	5.96"	2.75"	9.09"	1.25"
TC-050-4-1-181-S	1-13/16"	.437"	.500"	5.96"	2.75"	9.20"	1.25"
TC-050-4-1-200-S	2"	.437"	.500"	5.96"	2.75"	9.31"	1.25"
TC-050-4-1-218-S	2-3/16"	.437"	.500"	5.96"	2.75"	9.42"	1.25"
TC-050-4-1-237-S	2-3/8"	.437"	.500"	5.96"	2.75"	9.53"	1.25"

METRIC

MISSING LINK 1/2" DRIVE, 4:1 RATIO

MAX.: 340 NEWTON METERS IN / 1360 NEWTON METERS OUTPUT

PART NO.	HEX	"A"	"B"	"C"	"D"	"E"	"F"
TC-050-4-1-22MM	22 MM	13.5	15.1	151	70	222	32
TC-050-4-1-24MM	24 MM	12.0	13.5	151	70	222	32
TC-050-4-1-27MM	27 MM	11.1	12.7	151	70	222	32
TC-050-4-1-30MM	30 MM	12.0	13.5	151	70	226	32
TC-050-4-1-32MM	32 MM	11.1	12.7	151	70	226	32
TC-050-4-1-36MM	36 MM	11.1	12.7	151	70	228	32
TC-050-4-1-41MM	41 MM	11.1	12.7	151	70	231	32
TC-050-4-1-46MM	46 MM	11.1	12.7	151	70	234	32
TC-050-4-1-50MM	50 MM	11.1	12.7	151	70	236	32
TC-050-4-1-55MM	55 MM	11.1	12.7	151	70	239	32
TC-050-4-1-60MM	60 MM	11.1	12.7	151	70	242	32

MISSING LINK 3/4" DRIVE, 4:1 RATIO

MAXIMUM TORQUE: 600 FT. LBS. INPUT / 2400 FT. LBS. OUTPUT

PART NO.	HEX	"A"	"B"	"C"	"D"	"E"	"F"
TC-075-4-1-087-S	7/8"	.842"	.936"	8.34"	3.75"	12.17"	1.75"
TC-075-4-1-106-S	1-1/16"	.752"	.846"	8.34"	3.75"	12.17"	1.75"
TC-075-4-1-125-S	1-1/4"	.652"	.746"	8.34"	3.75"	12.17"	1.75"
TC-075-4-1-143-S	1-7/16"	.562"	.656"	8.34"	3.75"	12.17"	1.75"
TC-075-4-1-162-S	1-5/8"	.562"	.656"	8.34"	3.75"	12.28"	1.75"
TC-075-4-1-181-S	1-13/16"	.562"	.656"	8.34"	3.75"	12.38"	1.75"
TC-075-4-1-200-S	2"	.562"	.656"	8.34"	3.75"	12.49"	1.75"
TC-075-4-1-218-S	2-3/16"	.562"	.656"	8.34"	3.75"	12.60"	1.75"
TC-075-4-1-237-S *	2-3/8"	.562"	.656"	8.34"	3.75"	14.27"	1.75"
TC-075-4-1-256-S	2-9/16"	.562"	.656"	8.34"	3.75"	12.82"	1.75"
TC-075-4-1-275-S	2-3/4"	.562"	.656"	8.34"	3.75"	12.92"	1.75"
TC-075-4-1-293-S	2-15/16"	.562"	.656"	8.34"	3.75"	13.03"	1.75"
TC-075-4-1-312-S	3-1/8"	.562"	.656"	8.34"	3.75"	13.14"	1.75"

*FOR USE WITH YAW PUCKS

MISSING LINK 3/4" DRIVE, 4:1 RATIO

MAX.: 815 NEWTON METERS IN / 3260 NEWTON METERS OUT

PART NO.	HEX	"A"	"B"	"C"	"D"	"E"	"F"
TC-075-4-1-22MM	22 MM	21.3	23.6	212	95	309	45
TC-075-4-1-24MM	24 MM	20.3	22.6	212	95	309	45
TC-075-4-1-27MM	27MM	18.8	21.1	212	95	309	45
TC-075-4-1-30MM	30 MM	17.3	19.6	212	95	309	45
TC-075-4-1-32MM	32 MM	16.3	18.6	212	95	309	45
TC-075-4-1-36MM	36 MM	14.3	16.6	212	95	309	45
TC-075-4-1-41MM	41 MM	14.3	16.6	212	95	312	45
TC-075-4-1-46MM	46 MM	14.3	16.6	212	95	315	45
TC-075-4-1-50MM	50 MM	14.3	16.6	212	95	317	45
TC-075-4-1-55MM	55 MM	14.3	16.6	212	95	320	45
TC-075-4-1-60MM	60 MM	14.3	16.6	212	95	323	45
TC-075-4-1-65MM	65 MM	14.3	16.6	212	95	325	45
TC-075-4-1-70MM	70 MM	14.3	16.6	212	95	328	45
TC-075-4-1-75MM	75 MM	14.3	16.6	212	95	331	45
TC-075-4-1-80MM	80 MM	14.3	16.6	212	95	334	45

MISSING LINK 3/4" DRIVE, 6:1 RATIO

MAXIMUM TORQUE: 600 FT. LBS. INPUT / 3600 FT. LBS. OUTPUT

PART NO.	HEX	"A"	"B"	"C"	"D"	"E"	"F"
TC-075-6-1-125-S	1-1/4"	.942"	1.04"	13.98"	4"	18.75"	1.75"
TC-075-6-1-143-S	1-7/16"	.852"	.946"	13.98"	4"	18.75"	1.75"
TC-075-6-1-162-S	1-5/8"	.752"	.846"	13.98"	4"	18.75"	1.75"
TC-075-6-1-181-S	1-13/16"	.662"	.756"	13.98"	4"	18.75"	1.75"
TC-075-6-1-200-S	2"	.562"	.656"	13.98"	4"	18.75"	1.75"
TC-075-6-1-218-S	2-3/16"	.562"	.656"	13.98"	4"	18.86"	1.75"
TC-075-6-1-237-S	2-3/8"	.562"	.656"	13.98"	4"	18.97"	1.75"
TC-075-6-1-256-S	2-9/16"	.562"	.656"	13.98"	4"	19.08"	1.75"
TC-075-6-1-275-S	2-3/4"	.562"	.656"	13.98"	4"	19.19"	1.75"
TC-075-6-1-293-S	2-15/16"	.562"	.656"	13.98"	4"	19.30"	1.75"
TC-075-6-1-312-S	3-1/8"	.562"	.656"	13.98"	4"	19.41"	1.75"
TC-075-6-1-350-S	3-1/2"	.562"	.656"	13.98"	4"	19.62"	1.75"
TC-075-6-1-387-S	3-7/8"	.562"	.656"	13.98"	4"	19.84"	1.75"

MISSING LINK 3/4" DRIVE, 6:1 RATIO

MAX.: 815 NEWTON METER IN / 4890 NEWTON METERS OUT

PART NO.	HEX	"A"	"B"	"C"	"D"	"E"	"F"
TC-075-6-1-32MM	32 MM	23.3	25.6	355	102	476	45
TC-075-6-1-36MM	36 MM	21.3	23.6	355	102	476	45
TC-075-6-1-41MM	41 MM	18.8	21.1	355	102	476	45
TC-075-6-1-46MM	46 MM	16.3	18.6	355	102	476	45
TC-075-6-1-50MM	50 MM	14.3	16.6	355	102	476	45
TC-075-6-1-55MM	55 MM	14.3	16.6	355	102	479	45
TC-075-6-1-60MM	60 MM	14.3	16.6	355	102	481	45
TC-075-6-1-65MM	65 MM	14.3	16.6	355	102	484	45
TC-075-6-1-70MM	70 MM	14.3	16.6	355	102	487	45
TC-075-6-1-75MM	75 MM	14.3	16.6	355	102	490	45
TC-075-6-1-80MM	80 MM	14.3	16.6	355	102	493	45
TC-075-6-1-90MM	90 MM	14.3	16.6	355	102	498	45
TC-075-6-1-100MM	100 MM	14.3	16.6	355	102	504	45

MISSING LINK™

TORQUE MULTIPLIER



The Norwolf Missing Link™ torque multiplier fits into tightly confined areas where sockets will not fit. The Missing Link has become standard in the wind industry for generator feet and yaw pucks.



The newly re-designed 6:1 Missing Link™ fits in the narrowest of confines while maintaining a high power to weight ratio.

NORWOLF Missing Link™ Benefits:

- Accurate—operates using levers, not gears.
- No overload pins to break—creates safer working environment.
- Uses ratchet or non-ratchet wrenches.
- Optional reaction arm permits operator to react on the same plane.
- Input force is same direction as reaction force for maximum operator convenience.



MISSING LINK™ Z SERIES™



Custom sockets and adapters available.

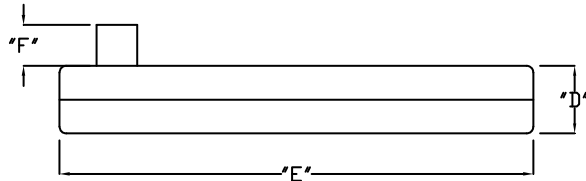
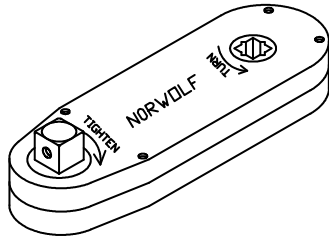
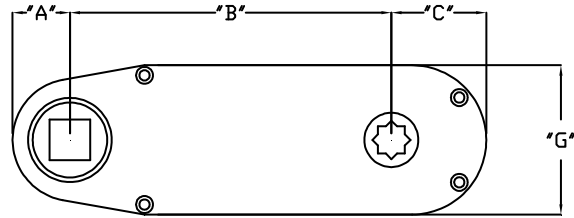

MODEL	INPUT DR.	OUTPUT DR.	MULTIPLICATION	MAX. TORQUE INPUT / OUTPUT	ACCURACY
Z46	.50"	.75"	3.9 : 1	250 / 1000 ft. lbs.	+/- 7.5%
Z460	.75"	1.00"	3.9 : 1	600 / 2400 ft. lbs.	+/- 7.5%
Z600	.75"	1.50"	6 : 1	600 / 3600 ft. lbs.	+/- 7.5%

MODEL	"A"	"B"	"C"	"D"	"E"	"F"	"G"
Z46	1.06"	5.95"	1.76"	1.25"	8.78"	.75"	2.75"
Z460	1.37"	8.34"	2.43"	1.75"	12.12"	1.00"	3.75"
Z600	1.87"	10.48"	3.06"	1.75"	14.56"	1.50"	4.00"

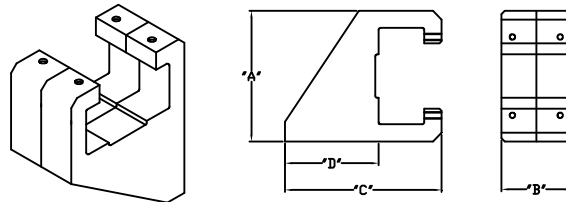

OPTIONAL REACTION ARM

MODEL	"A"	"B"	"C"	"D"
Z46	3.75"	1.62"	4.50"	2.68"
Z460	4.75"	2.38"	5.25"	2.87"
Z600	5.00"	2.62"	6.25"	3.87"



MISSING LINK™

Z SERIES



The Norwolf Z series torque multiplier is the slimmest square drive multiplier ever created. Use with standard sockets and optional reaction arm to fit all applications.



NORWOLF Z46, Z460 & Z600 Benefits:

- Accurate—operates using levers, not gears.
- No overload pins to break—creates safer working environment.
- Uses ratchet or non-ratchet wrenches.
- Optional reaction arm permits operator to react on the same plane.
- Input force is same direction as reaction force for maximum operator convenience.





XCELINK™

CONTINUOUS TURN TORQUE MULTIPLIER



The Norwolf Xcelink™ is the ultimate answer for gaining access where standard pneumatic multipliers are too tall or bulky to fit application. The Norwolf Xcelink™ is essentially a Missing Link™ with the ability to turn continuously. There are two available styles. The standard style has a sliding pin with which to react with any standard pneumatic torque wrench. The hub style has a specific splined hub to match the input tool of choice. All hubs can be interchanged for added versatility.



NORWOLF Xcelink™ Benefits:

- 3:1 or 4:1 ratios.
- Totally enclosed aircraft aluminum housing.
- Available in two styles, pin or hub reaction.
- Continuous rotation for use with any pneumatic or electric wrench.
- Available in special configurations.
- Gearless internal design offers long service life.

Please visit www.norwolf.com for dimensional data.

TRIBECA™ Boxtower

HYDRAULIC TORQUE MULTIPLIER



The world's smallest, lightest, box style hydraulic wrench. Straight profile fits easily into tight areas.

Tribeca Boxtower Benefits:

- Can be used with hydraulic pump or manual wrench.
- 2:1 torque multiplication with manual wrench.
- Totally enclosed aircraft aluminum body.
- Light weight, slim-line body.
- Available in single and double acting.
- Available in square drive and low profile.
- Available in 6 or 12 points.
- Patented disengagable reaction pawl.
- Built in alloy steel reaction block.
- Optional reaction arm available.

Please visit www.norwolf.com for dimensional data.





Norwolf Tool Works Inc.

6 Sullivan Street
Westwood, NJ 07675
Tel: 201-666-6655
Fax: 201-666-7611
www.norwolf.com

Distributed By:

